



# OX-B431 Oxidising Gas Sensor Ozone + Nitrogen Dioxide 4-Electrode



Patented

**Figure 1 OX-B431 Schematic Diagram**

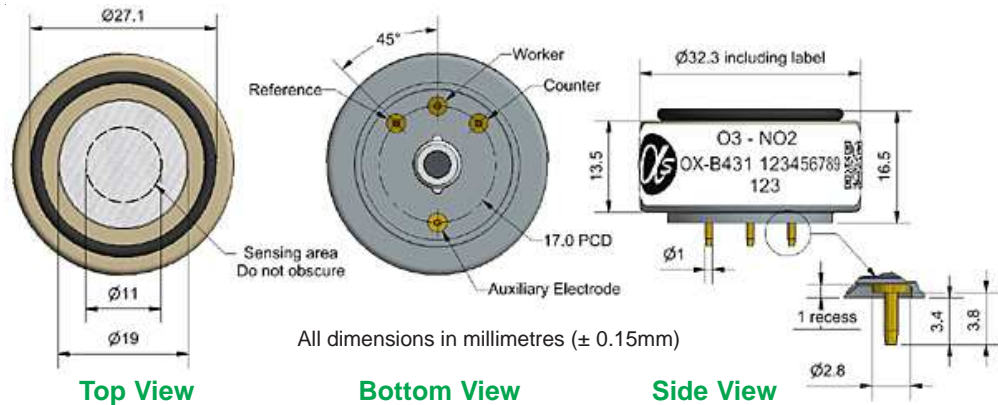

Technical Specification

## Specification O<sub>3</sub> Sensing

### PERFORMANCE

Sensitivity	nA/ppm at 1ppm O <sub>3</sub>	-225 to -550
Response time	t <sub>90</sub> (s) from zero to 1ppm O <sub>3</sub>	< 45
Zero current	nA in zero air at 20°C	-50 to 70
Noise*	±2 standard deviations (ppb equivalent)	15
Range	ppm O <sub>3</sub> limit of performance warranty	20
Linearity	ppm error at full scale, linear at zero and 20ppm O <sub>3</sub>	< ±0.5
Overgas limit	maximum ppm for stable response to gas pulse	50

\* Tested with Alphasense AFE low noise circuit

### LIFETIME

Zero drift	ppb equivalent change/year in lab air	0 to 20
Sensitivity drift	% change/year in lab air, monthly test	< -20 to -40
Operating life	months until 50% original signal (24 month warranted)	> 24

### ENVIRONMENTAL

Sensitivity @ -20°C	(% output @ -20°C/output @ 20°C) @ 2ppm O <sub>3</sub>	70 to 90
Sensitivity @ 40°C	(% output @ 40°C/output @ 20°C) @ 2ppm O <sub>3</sub>	95 to 125
Zero @ -20°C	nA	0 to 25
Zero @ 40°C	nA	5 to 100

### CROSS SENSITIVITY

H <sub>2</sub> S	sensitivity % measured gas @ 5ppm	H <sub>2</sub> S	< 170
NO	sensitivity % measured gas @ 5ppm	NO	< 5
Cl <sub>2</sub>	sensitivity % measured gas @ 5ppm	Cl <sub>2</sub>	< 90
SO <sub>2</sub>	sensitivity % measured gas @ 5ppm	SO <sub>2</sub>	< -7
CO	sensitivity % measured gas @ 5ppm	CO	< 0.1
C <sub>2</sub> H <sub>4</sub>	sensitivity % measured gas @ 100ppm	C <sub>2</sub> H <sub>4</sub>	< 0.1
NH <sub>3</sub>	sensitivity % measured gas @ 20ppm	NH <sub>3</sub>	< 0.1
H <sub>2</sub>	sensitivity % measured gas @ 100ppm	H <sub>2</sub>	< 0.1
CO <sub>2</sub>	sensitivity % measured gas @ 5% Vol	CO <sub>2</sub>	0.1
Halothane	sensitivity % measured gas @ 100ppm	Halothane	< 0.1

### KEY SPECIFICATIONS

Temperature range	°C	-30 to 40
Pressure range	kPa	80 to 120
Humidity range	% rh continuous	15 to 85
Storage period	months @ 3 to 20°C (stored in sealed pot)	6
Load resistor	Ω (AFE circuit recommended)	33 to 100
Weight	g	< 6

**NOTE:** all sensors are tested at ambient environmental conditions, with 47 ohm load resistor, unless otherwise stated. As applications of use are outside our control, the information provided is given without legal responsibility. Customers should test under their own conditions, to ensure that the sensors are suitable for their own requirements.



# OX-B431 Performance Data

# Technical Specification

**Figure 2 Sensitivity temperature dependence to 1ppm O<sub>3</sub>**

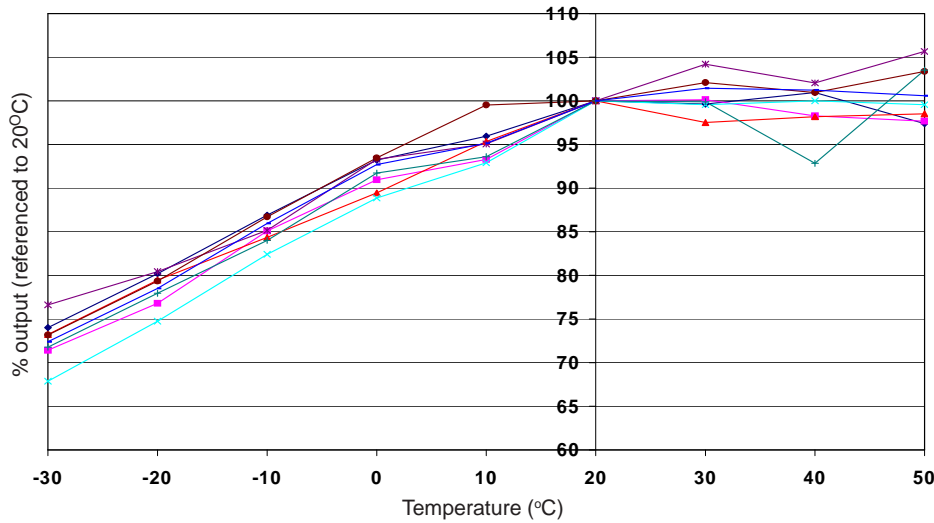

Figure 2 shows the temperature dependence of sensitivity at 1ppm O<sub>3</sub>.

This data is taken from a typical batch of sensors.

**Figure 3 Zero temperature dependence**

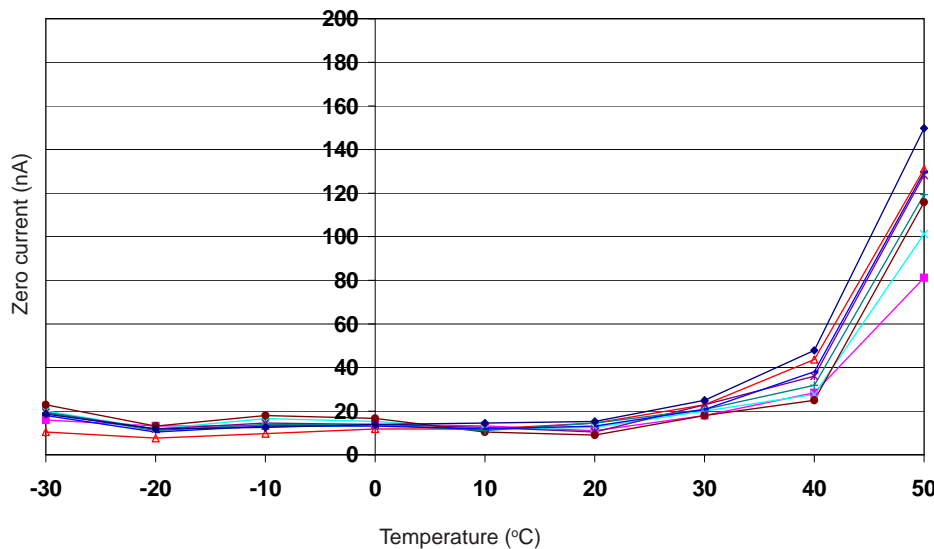

Figure 3 shows the variation in zero output of the working electrode caused by changes in temperature, expressed as nA.

This data is taken from a typical batch of sensors.

Contact Alphasense for further information on zero current correction.

**Figure 4 Response from 200 ppb to 0 ppb O<sub>3</sub>**

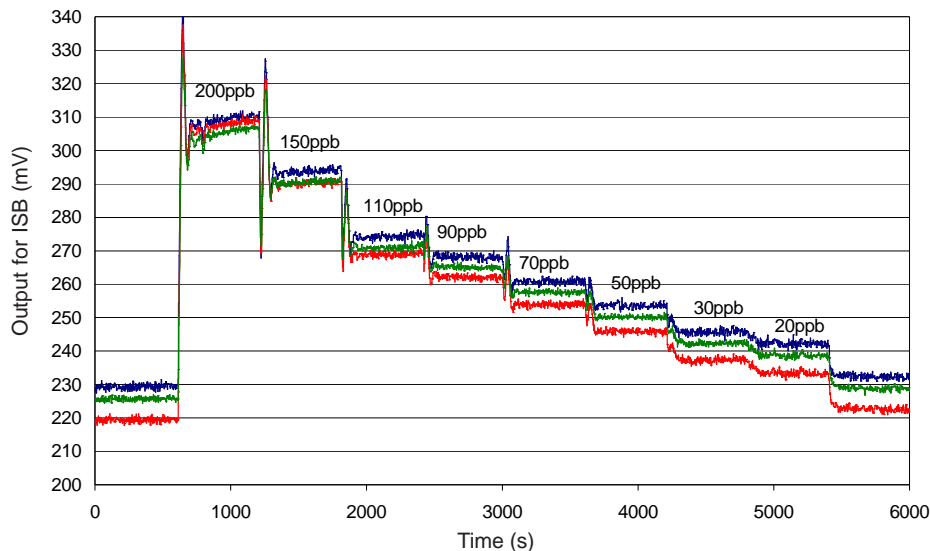

Figure 4 shows response from 200ppb O<sub>3</sub> to 0ppb O<sub>3</sub>.

Use of Alphasense AFE circuit reduces noise to 15ppb, with the opportunity of digital smoothing to reduce noise even further.

Offset voltage is due to intentional ISB circuit electronic offset.



# OX-B431 Oxidising Gas Sensor Ozone + Nitrogen Dioxide 4-Electrode

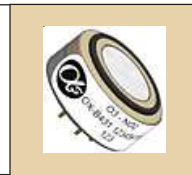

Patented

The OX-B431 detects both ozone and nitrogen dioxide (O<sub>3</sub> +NO<sub>2</sub>). The NO2-B43F measures only nitrogen dioxide, filtering out ozone. Using these sensors together allows you to calculate the O<sub>3</sub> concentration by subtracting the corrected NO2-B43F concentration from the corrected OX-B431 concentration.

Before subtracting to determine ozone concentration, ensure that the signals from the two sensors have been corrected for electronic zero offset, sensor zero offset and temperature dependence, and sensitivity (nA/ppm) calibration and temperature dependence.

## Specification NO<sub>2</sub> Sensing

### PERFORMANCE

Sensitivity to NO <sub>2</sub>	nA/ppm at 2ppm NO <sub>2</sub>	-250 to -650
Response time	t <sub>90</sub> (s) from zero to 2ppm NO <sub>2</sub>	< 35
Zero current	nA in zero air at 20°C	-50 to +70
Noise*	±2 standard deviations (ppb equivalent)	15
Range	ppm NO <sub>2</sub> limit of performance warranty	20
Linearity	ppm error at full scale, linear at zero and 20ppm NO <sub>2</sub>	< ±0.5
Overgas limit	maximum ppm for stable response to gas pulse	50

\* Tested with Alphasense AFE low noise circuit

### LIFETIME

Zero drift	ppb equivalent change/year in lab air	0 to 20
Sensitivity drift	% change/year in lab air, monthly test	< -20 to -40
Operating life	months until 50% original signal (24 month warranted)	> 24

### ENVIRONMENTAL

Sensitivity @ -20°C	(% output @ -20°C/output @ 20°C) @ 2ppm NO <sub>2</sub>	70 to 90
Sensitivity @ 40°C	(% output @ 50°C/output @ 20°C) @ 2ppm NO <sub>2</sub>	95 to 110
Zero @ -20°C	nA	0 to 25
Zero @ 40°C	nA	5 to 50

### CROSS SENSITIVITY

H <sub>2</sub> S	sensitivity % measured gas @ 5ppm	H <sub>2</sub> S	< 170
NO	sensitivity % measured gas @ 5ppm	NO	< 5
Cl <sub>2</sub>	sensitivity % measured gas @ 5ppm	Cl <sub>2</sub>	< 90
SO <sub>2</sub>	sensitivity % measured gas @ 5ppm	SO <sub>2</sub>	< -7
CO	sensitivity % measured gas @ 5ppm	CO	< 0.1
C <sub>2</sub> H <sub>4</sub>	sensitivity % measured gas @ 100ppm	C <sub>2</sub> H <sub>4</sub>	< 0.1
NH <sub>3</sub>	sensitivity % measured gas @ 20ppm	NH <sub>3</sub>	< 0.1
H <sub>2</sub>	sensitivity % measured gas @ 100ppm	H <sub>2</sub>	< 0.1
CO <sub>2</sub>	sensitivity % measured gas @ 5% Vol	CO <sub>2</sub>	0.1
Halothane	sensitivity % measured gas @ 100ppm	Halothane	< 0.1

### KEY SPECIFICATIONS

Temperature range	°C	-30 to 40
Pressure range	kPa	80 to 120
Humidity range	% rh continuous	15 to 85 < 6



At the end of the product's life, do not dispose of any electronic sensor, component or instrument in the domestic waste, but contact the instrument manufacturer, Alphasense or its distributor for disposal instructions.

**NOTE:** all sensors are tested at ambient environmental conditions, with 47 ohm load resistor, unless otherwise stated. As applications of use are outside our control, the information provided is given without legal responsibility. Customers should test under their own conditions, to ensure that the sensors are suitable for their own requirements.



# OX-B431 Performance Data

# Technical Specification

**Figure 5 Sensitivity temperature dependence to 2ppm NO<sub>2</sub>**

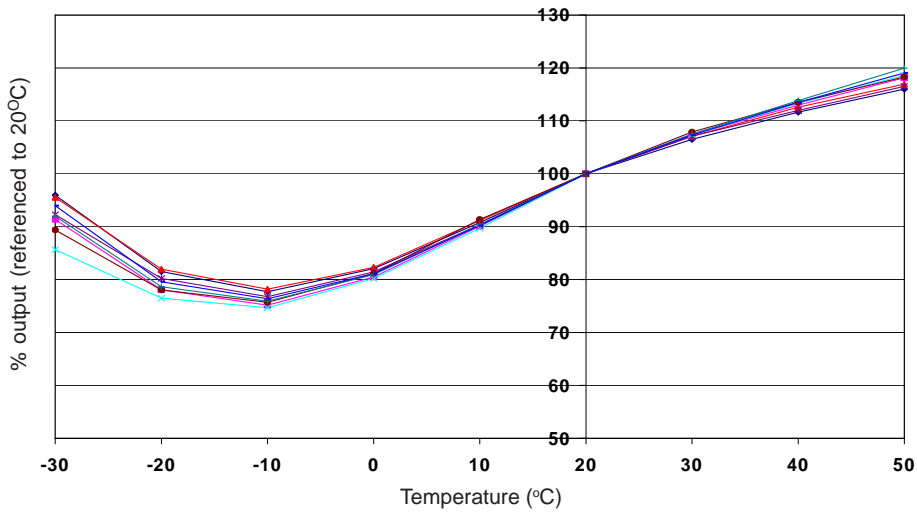

Figure 5 shows the temperature dependence of sensitivity at 2ppm NO<sub>2</sub>.

This data is taken from a typical batch of sensors.

**Figure 6 Response to 50ppb NO<sub>2</sub>**

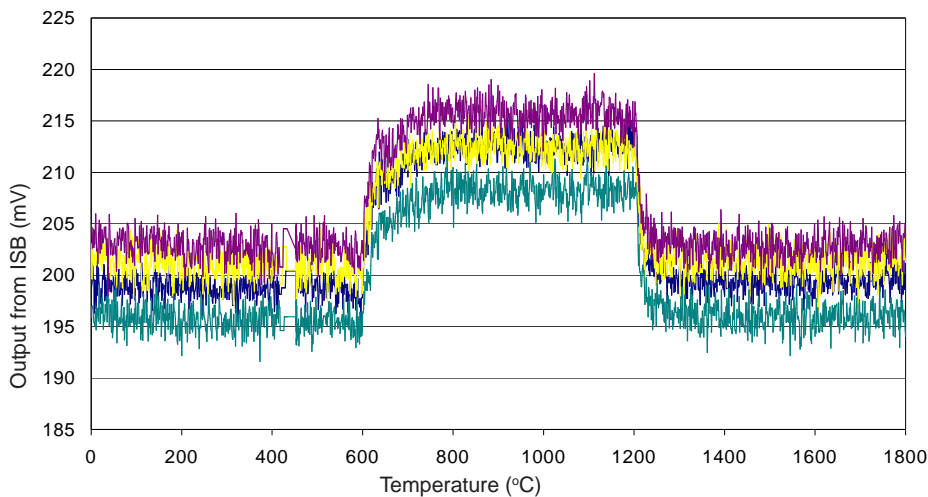

Figure 6 shows the fast response and good baseline recovery of the OX-B431 to 50ppb NO<sub>2</sub>.

**Figure 7 Response from 200 ppb to 0 ppb NO<sub>2</sub>**

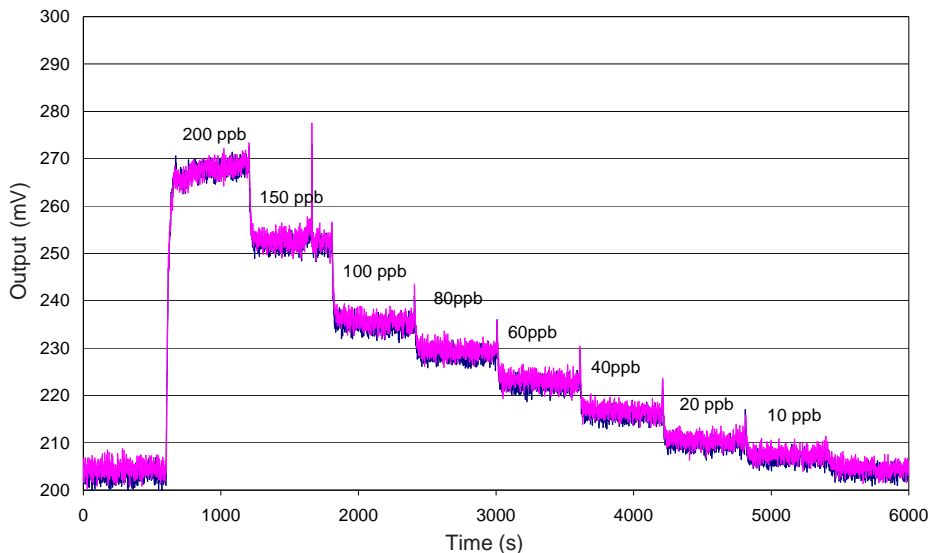

Figure 7 shows response from 200ppb NO<sub>2</sub> to 0ppb NO<sub>2</sub>.

Use of Alphasense AFE circuit reduces noise to 15ppb, with the opportunity of digital smoothing to reduce noise to less than ± 5ppb.

Offset voltage is due to intentional ISB circuit electronic offset.

For further information on the performance of this sensor, on other sensors in the range or any other subject, please contact Alphasense Ltd. For Application Notes visit "[www.alphasense.com](http://www.alphasense.com)".

In the interest of continued product improvement, we reserve the right to change design features and specifications without prior notification. The data contained in this document is for guidance only. Alphasense Ltd accepts no liability for any consequential losses, injury or damage resulting from the use of this document or the information contained within. (©ALPHASENSE LTD ) Doc. Ref. OX-B431/APR16